

# TAKT™

## T21 Curve Coat Rack

Building Instructions

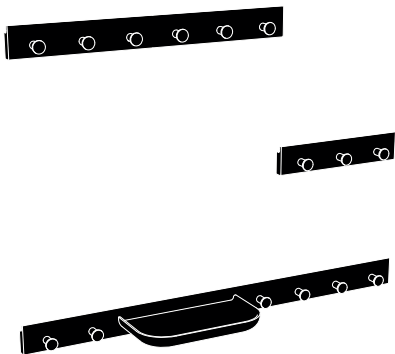

## Important Notice

Only use the listed tools.

Do **not** use power tools.

Tighten in accordance with the building instructions.

Avoid over-tightening.

There is no need for strong force.

30cm version:

1x rack



3x knobs



60cm version:

1x rack

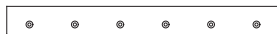

6x knobs



90cm version:

1x rack



9x knobs



Optional:

1x shelf

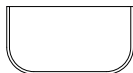

**A** Screw  
30cm  
↑  
60cm  
↑↑↑↑  
90cm  
↑↑↑↑↑↑↑↑  
Shelf  
↑↑

**B** Plug  
30cm  
||  
60cm  
||  
90cm  
||  
Shelf  
|||

**C** Dowel screw  
30cm  
||  
60cm  
||  
90cm  
||  
Shelf  
|||

**a** 1x Allen key (SW4)



**b** 1x Torx key (TX15)



## Product Information

'T21 Curve Coat Rack'  
is a coat rack designed for  
indoor use. The coat rack is  
tested according to EN-16121 -  
L1.

### Weight

90cm version:  
720 g

60cm version:  
480 g

30cm version:  
240 g

Shelf:  
620 g

### Materials

Rack: Solid wood  
Knobs: Solid wood  
Shelf: Solid wood  
Surface treatment: Water based lacquer  
Fittings: Steel

### Tests & Declarations

The coat rack has passed the furniture test  
EN-16121 - L1  
The coat rack is not treated with or containing  
disinfective biocides.



The mark of  
responsible forestry

## Dimensions

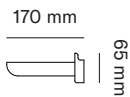
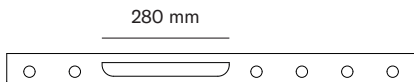
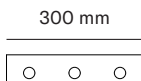
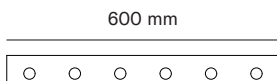
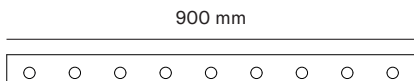

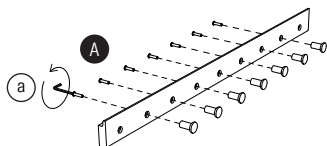

6



## Optional

### Shelf

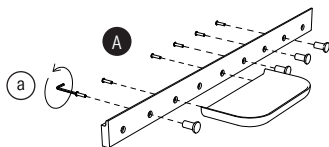

The shelf can be mounted on the 90cm and 60cm wide coat rack.  
The shelf can be positioned in any of the knob holes except for the outermost holes as these are intended for the wall mounting.

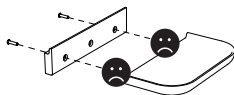
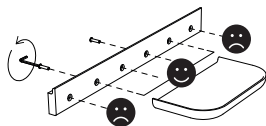
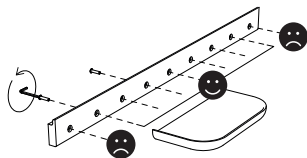

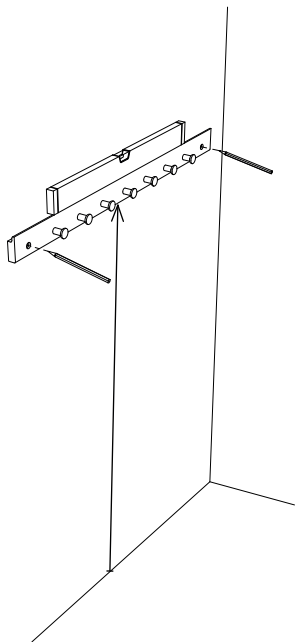

8

Find the desired height above the floor. Place a spirit level on the top edge of the coat rack. Mark the drilling marks through the outermost knob holes.



Two plugs are provided for mounting in hard walls - eg. concrete or brick walls. Drill the holes at the drilling marks and place the plugs.

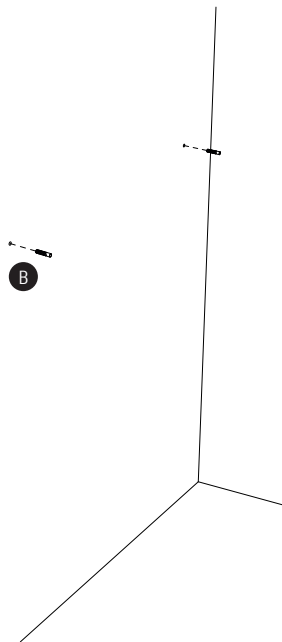

**Important!**

Screw the dowel screw into the wall until it reaches the blank part.

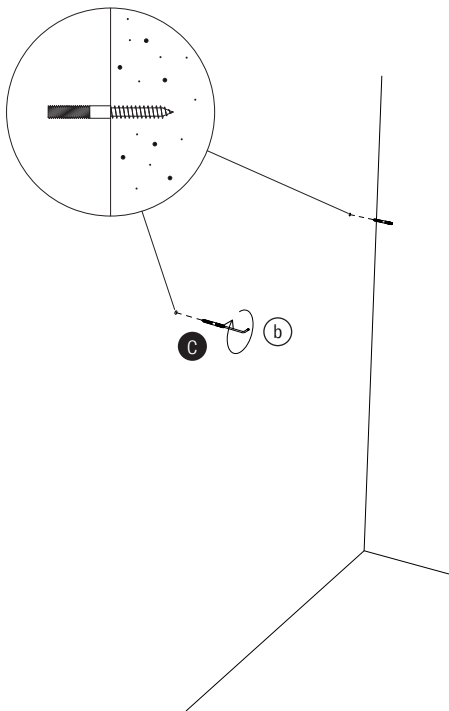

10



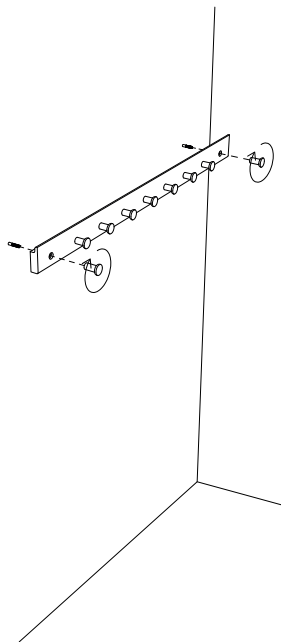

Place the coat rack on the dowel screws. Gently hand tighten the knobs until the coat rack is flush with the wall.

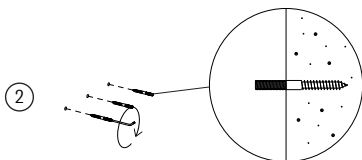

Screw the dowl screw into the wall until it passes the blank part.





## **Additional Information**

TAKT provides an extended warranty of 5 years on 'T21 Curve Coat Rack'.

### **Warranty**

TAKT provides an extended warranty of 5 years on 'T21 Curve Coat Rack'. The warranty covers breakage of components and damage occurred because of deficient craftsmanship under normal use.

The warranty shall lapse if the product shows signs of inappropriate use or other physical damage. The warranty does not cover wear or damage to upholstery, gliders, wheels, surfaces and the like.

### **Maintenance**

TAKT maintenance guide is accessible on our website

[www.taktcp.com/  
product-care/](http://www.taktcp.com/product-care/)

### **Spare Parts**

TAKT offers spare parts for 'T21 Curve Coat Rack'. Spare parts are available from TAKT without charge for a period of 5 years from the date of purchase if the parts are found to be faulty during normal use. If the parts are damaged by misuse spare parts can be bought from TAKT.

TAKT always strives to deliver spare parts to you in the fastest and most efficient way in order for your furniture to return to a functional condition.

Please contact TAKT for inquiries regarding spare parts.

### **Recycling & Disassembly**

We hope that your TAKT product will serve you well for many, many years.

If you at one point want to recycle it, please separate it into components for sorting.

Untighten screws by turning the Allen and Torx key counter clockwise to separate the different parts.

Metal parts and plastic parts can be delivered to a suitable recycling facility and be recycled.

Wooden parts can be delivered to a suitable recycling facility and be recycled or used for energy recovery through incineration.

[info@taktcp.com](mailto:info@taktcp.com)

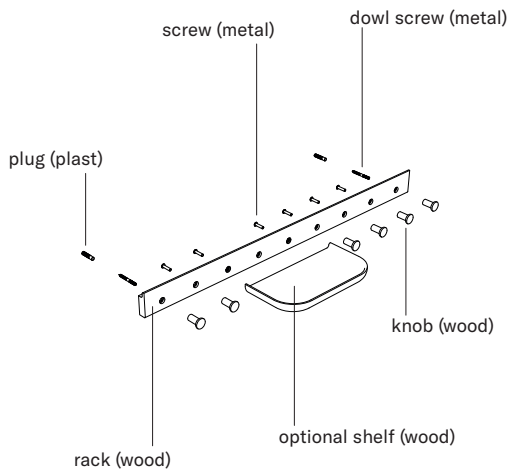

# **TAKT**<sup>TM</sup>

---

[taktcph.com](http://taktcph.com)